

---

# Impact of the Biofuels Burning on Particle Emissions from the Vehicular Exhaust

---

Lílian Lefol Nani Guarieiro and Aline Lefol Nani Guarieiro

Additional information is available at the end of the chapter

<http://dx.doi.org/10.5772/60110>

---

## 1. Introduction

To help address continuing environmental and public health degradation, most governments adhere to international energy policies with regard to the use of biofuels. The increased environmental concerns, depletion of petroleum, public health and socioeconomic challenges have driven research to develop alternative fuels from renewable resources that are cheaper and environmentally acceptable.

In the last years, the use of alternative fuels has been shown to reduce emissions without negative effects on engine performance. There are also some studies that demonstrate an increase in particle emission with the use of biofuels. However, the literature reviewed here found noticeable decrease in particle emissions and smoke opacity with the use of biofuels. Indeed, many studies have been conducted to characterize and better understand biofuel properties related to particle emission.

The particles emitted by combustion of vehicle engines can be distributed in different ranges of size and number of particles. The particle size distributed in the range covering the nano-particles (particles smaller or equal to 100 nm) has a greater toxic potential compared with a larger particle. Studies suggest that exposure to nanoparticles causes serious damage to health, such as lung inflammation, asthma, chronic obstruction of arteries and lungs, cell death, obstruction and accumulation in the olfactory bulb, access to brain damage, tumor necrosis, oxidative stress, neural effects, heart problems, and even death.

Particles emitted from combustion of vehicle engines can also be of different chemical and toxicological properties. The chemical composition of particle emission is directly related to the burned fuel and vehicular exhaust condition, and may affect its toxicity. Studies suggest that the higher the organic carbon composition is, the higher damage of particle emitted will be to health.

Conscious about this subject, there is now considerable research and investment on the kind of fuel and biofuel to develop and promote fuels able to minimize the toxicity and particle emissions from vehicular exhausts. Thus, the viability of using biofuels, its impact on public health and environment, and the impact of biodiesel burning on particle emissions from vehicular exhaust, can be better understood.

## 2. Origin and characterization of particles

The particles present in the atmosphere have diverse origins from multiples sources. Particles consist of a conglomerate of solid particles with variable sizes and physical-chemical proprieties presenting a toxicity level dependent on its size and chemical composition [1]. According EPA, particle or particle matter (PM) is a complex mixture of extremely small particles and liquid droplets. Particle pollution is made up of a number of components, including acids (such as nitrates and sulfates), organic chemicals, metals, and soil or dust particles [2].

There are many sources of PM. An air pollutant can originate from natural processes, like forest fires and wind erosion, and from human activities, like agricultural practices, smokestacks, vehicular emissions, and construction. Examples include dust, dirt, soot, soil, and smoke [2]. In this chapter, we will focus on vehicular sources of particles and the impacts of biofuel burning in this concentration and size distribution.

The particle size is an important propriety and is related to its inhalable potential causing the particle to get into the human respiratory system and then causing health problems [3]. Furthermore, particle size is one of the most important parameters in determining the atmospheric lifetime of particles, which is a key consideration in assessing health effect information because of its relationship to exposure. The US Environmental Protection Agency (EPA) have concerned about particles that are 10 micrometers in diameter or smaller because those are the particles that generally pass through the throat and nose and enter the lungs. Once inhaled, these particles can affect the heart and lungs and cause serious health problems. The EPA groups particle pollution into categories, these categories are based on studies that show a relationship between adverse health effects and the concentration of fine particles in the atmosphere:

"Inhalable coarse particles," such as those found near roadways and dusty industries, are larger than 2.5 micrometers and smaller than 10 micrometers in diameter ( $PM_{10}$ ). "Fine particles," such as those found in smoke and haze, are 2.5 micrometers in diameter and smaller ( $PM_{2.5}$ ). These particles can be directly emitted from sources such as forest fires, or they can form when gases emitted from power plants, industries and automobiles react in the air. The "Nanoparticles," such as those found close to combustion systems, are 100 nanometers in diameter and smaller. These particles can be directly emitted from sources such as vehicle combustions or any combustion source. Nanoparticles have been hardly studied by the scientific community to better understand its role and relationship with human health. Nanoparticles are also known as ultrafine particles.

The multi-modal distribution of particles based on diameter has long been recognized since the 1980. Notwithstanding, particles display a consistent multi-modal distribution over several physical metrics such as volume and mass; specific distributions may vary over place, conditions, and time because of different sources, atmospheric conditions, and topography [4]. Based on particle size and formation mechanism, particles can be classified into three fundamental modes: nuclei, fine, and coarse modes and particles can be observed in an idealized mass distribution of these modes (Figure 1). High temperature vapor, coagulation and condensation processes, aggregate formation, mechanical processes, precipitation washout and sedimentation process could contribute to the particle formation as seen on this figure.

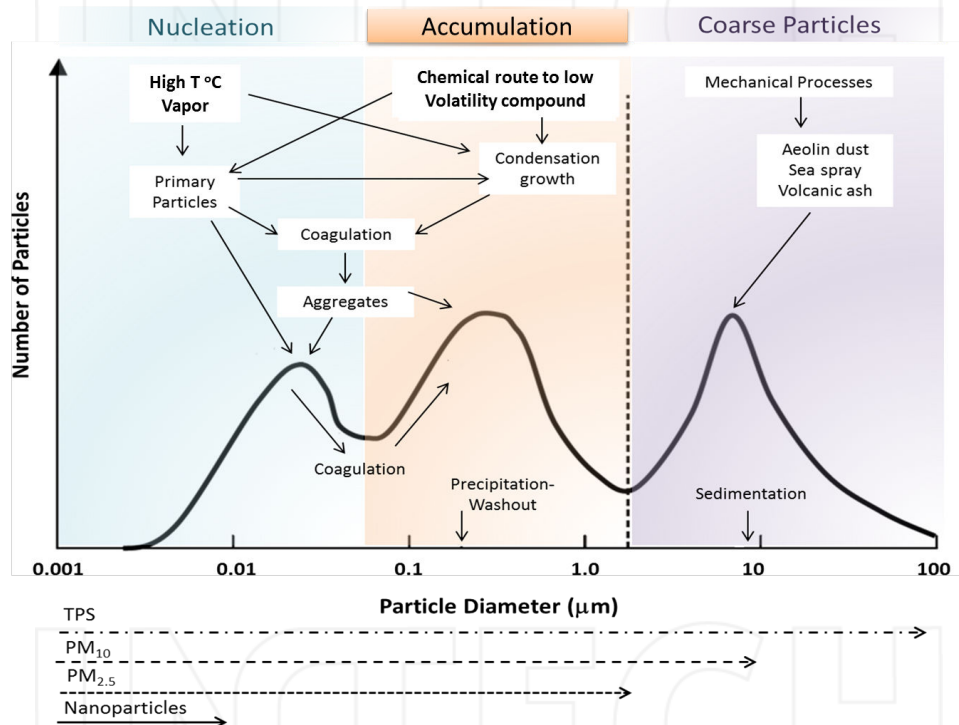

Figure 1. Particle size distribution, formation process, and multi-modal distribution [Adapted from EPA].

Nuclei-mode particles range in diameter from about 5 to 50 nm. They usually consist of particles formed from volatile precursors as exhaust mixes with air during dilution and cooling process, it consists of metallic compounds, elemental carbon, and semi-volatile organic and sulfur compounds. The accumulation mode ranges in size from roughly 30 to 500 nm. They consist mainly of carbonaceous agglomerates that have survived the combustion process, most of the mass, composed primarily of carbonaceous agglomerates and adsorbed materials. The coarse mode consists of particles larger than about 1 μm. These relatively large particles are

formed by natural material and re-entrainment of particulate matter, which has been deposited on cylinder and exhaust system surfaces. Also shown in Figure 1 are size range definitions for atmospheric particles: coarse particle  $PM_{10}$  (diameter  $< 10 \mu m$ ), fine particles  $PM_{2.5}$  (diameter  $< 2.5 \mu m$ ), and nanoparticles (diameter  $< 100 \text{ nm}$ ) [5-7].

The profile for the three modes can change with the characteristics of the emitting source. Figure 2 shows a typical diesel particle matter size distribution weighted by number, surface area, and particle mass; it also shows the alveolar deposition curve [8,9]. As particles increase in size, the deposition efficiency decreases. The most difficult thing about the measurement of engine exhaust size distributions is that most of the nanoparticles emitted by current engines are not formed in the engine itself, but instead are formed from gas phase precursors as the exhaust dilutes and cools. This gas-to-particle conversion process involves homogeneous nucleation, adsorption, and absorption, and is highly nonlinear.

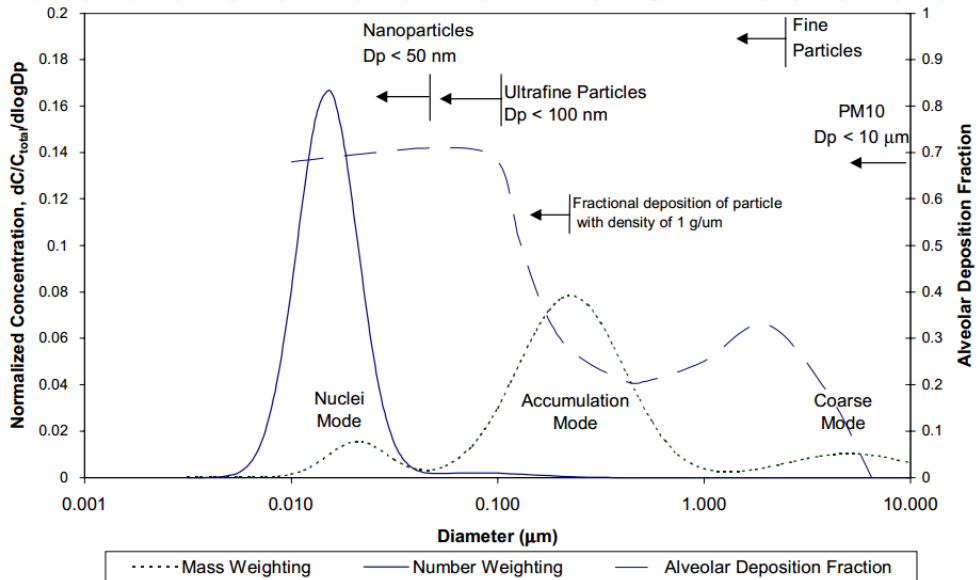

Figure 2. Typical diesel particle matter size distribution weighted by number, surface area, and particle mass [5].

The nuclei mode typically contains 1%-20% of the diesel particle matter mass and more than 90% of the particle number, and the coarse mode contains 5%-20% of the particle mass [5].

Nevertheless, particles are a complex, heterogeneous mixture that changes in time and space. It encompasses many different chemical components and physical characteristics, many of which have been cited as potential contributors to toxicity. Each component has multiple sources, and each source generates multiple components. Identifying and quantifying the influences of specific components or source-related mixtures on measures of health-related impacts, especially when particles interact with other co-pollutants, there-

fore represents one of the most challenging areas of environmental health research. Current knowledge does not allow precise quantification or definitive ranking of the health effects of PM emissions from different sources or of individual PM components and indeed, associations may be the result of multiple components acting on different physiological mechanisms [10]. In this universe, the impact of biofuel burning on particle emissions from vehicular exhaust is just as challenging.

However, chemical composition is an important propriety, generally, particles constitute biological materials, organic compounds, hydrocarbons, acid, metals adsorbed or attached on its carbonaceous structures. Chemical composition is directly related to the emitting source. Particles are compounded by a carbonaceous nuclei and a huge number of substances adsorbed on its surface, such as organic compounds (OC) – polycyclic aromatic hydrocarbons (PAH), PAH-derivatives (quinones, semi-quinones, nitro-PAH, carboxi-PAH) and inorganic compounds – metals, ions, inorganic acids, salts, among others [generated primarily by mechanical processes]. Much of the organic compounds are formed by complex secondary processes, through n-alkanes and hydroxyl radicals (OH ●) in the presence of NO<sub>x</sub> (Figure 3). On these processes, the type of product formed depends on the conditions of the combustion process that gave rise to particle and atmospheric conditions [11,12].

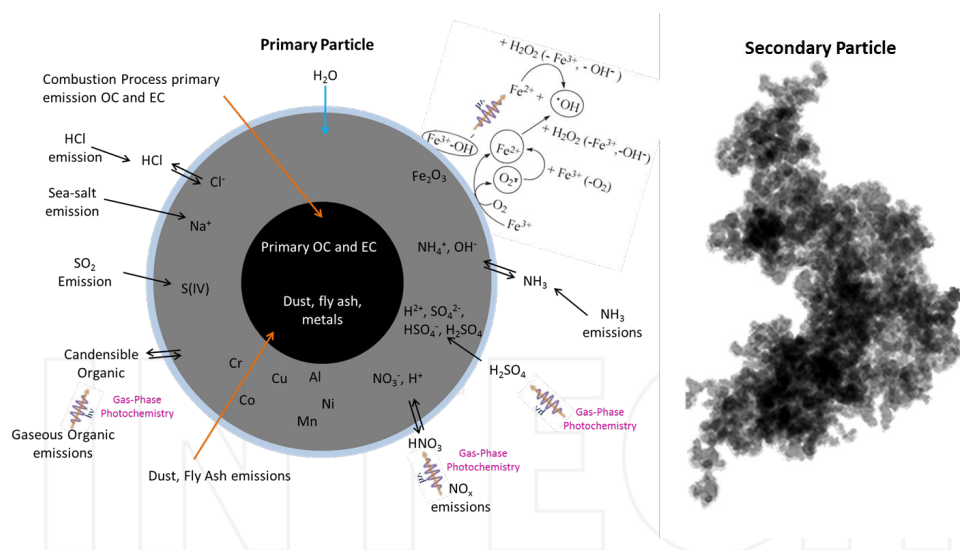

**Figure 3.** Primary and secondary particles, and chemical reactions and processes associated with the chemical composition.

Li et al. [13] demonstrated that in general, coarse particles of metal have a great contribution because fine metal particles and OC, and nanoparticles generally have OCs and PAHs. Due to the small size of the nanoparticles and large surface area of these particles, they may carry metals and a large number of organic compounds, which when inhaled can be absorbed into

the respiratory tract. Many of these compounds are capable of generating reactive oxygen species (ROS) that promote toxicity cells [13].

Additionally, a study by Claxton et al. 2004 [14] reviewed the different classes of particle matter, including non-metallic organic, sulfur, and halogenated hydrocarbons, oxygenates, and nitrates. For hydrocarbons derived from combustion processes, there are various carcinogenic PAHs, such as benzo (a) anthracene, benzo (k) fluorene, Benzo (a) pyrene, benzo (b) fluoranthene, indeno (1,2,3-cd), pyrene, and dibenzo (ah) anthracene. Furthermore, many PAH are directly mutagenic as mono- and dinitro-HPA 1-nitropyrene and 3-nitrofluoranteno. Recent research has shown that quinones play a critical role in catalyzing the generation of ROS that promotes toxic effects on the human body [15,16]. Similarly, Kong et al. (2011) [17] demonstrated the ability of metals present in the MP as cobalt (Co), copper (Cu), iron (Fe), manganese (Mn), Nickel (Ni), vanadium (V) and titanium (Ti), to contribute to the increase of particle toxicity.

Thus, the purpose of this chapter is to describe the impact of biofuels on emissions of all particle size from vehicular exhaust. The particle emission profiles originating from both diesel and Otto cycle engines and the impact of the use of biofuels will be characterized.

### 3. Particle emissions from exhaust vehicles

The total particulate emission concentration from light-duty diesel engines is much smaller than that from heavy-duty diesel engines. In general, newer heavy-duty trucks emit diesel particulates at a rate 20 times that of catalyst-equipped gasoline-fueled vehicles [18]. The particle size distribution and chemical composition can vary greatly depending on the engine type, engine speed and load, and composition of fuel oil and lubricating emission control technology [19]. In addition, the reduction or increase in the emission of particles can be influenced by some factors as described below:

- The operating mode of the engine: operating in stratified condition, the total mass and the number of particulates are more than 20 times greater than in homogeneous operating conditions (air and fuel)
- The higher the engine speed, the shorter the time of vaporization of the fuel, and higher load regimes require a greater mass of fuel injected into the combustion chamber, which reduces the temperature within the chamber, thereby limiting the vaporization of fuel and generating larger amount of particles
- The type of fuel used in the engine.

#### 3.1. Profile of particle emissions from diesel engines

Engines that use diesel as fuel have many applications, mainly due to its higher thermal efficiency and fuel economy. In general, the diesel emissions consist of a nonpolar fraction, a moderately polar fraction, and a polar fraction [20,21]; the remainder is unrecoverable (Figure 4).

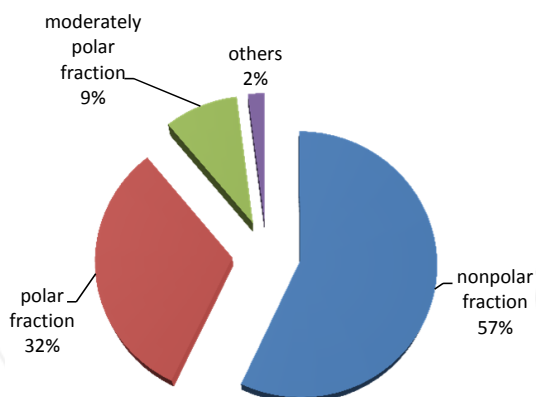

Figure 4. Diesel emission composition.

Particulate emission from diesel engines is receiving a great deal of attention due to its probable carcinogenic property. In the exhaust pipe of a diesel engine, the change of the exhaust gas temperature can result in nucleation and condensation of volatile materials and coagulation of particulates. These particles emitted from diesel engines are composed mainly of aggregates of spherical carbon particles coated with organic and inorganic substances, with the composition of the particles being predominantly 80%–90% organic and inorganic carbon (Figure 3). However, the particle composition may dramatically change depending on the engine type, engine speed and load, lubricating oil type, emission control technology, and fuel composition [19]. For this reason, it is not trivial to compare data from studies on carrier particles emitted in the exhaust using different parameters. Thus, it is necessary to study each parameter individually and setting the others to evaluate their effect on the concentration and distribution of particle size.

Sharma et al. (2005) [22] studied particle composition changing the engine load (Figure 5) and they observed the influence of the difference of engine load in the particle composition. The exhaust particulates from Mahindra direct injection transportation diesel engine (40 hp) were collected at four different engine operating conditions, namely idle, 40%, 70%, and full load. Figure 5 shows the diesel particle composition at 70% load in the study compared with the composition at 100% engine load. The broad composition of the particulates remains the same with the load and also when compared with the study of Volkswagen (1989). However, a closer examination suggested that the composition may dramatically change between OC and EC with a change in engine load. The authors observed that as the load increased from full load, the metal content in particulates, benzene soluble fraction (a marker for carcinogenicity), and OC gradually decreased. The trend for EC was quite the opposite, it increased with an increase in load.

The inorganic fraction of the particulate emissions consists primarily of small EC particles, ranging from 0.01 to 0.08  $\mu\text{m}$  in diameter. Organic and elemental carbon account for approximately 80% of the total particulate matter mass [23].

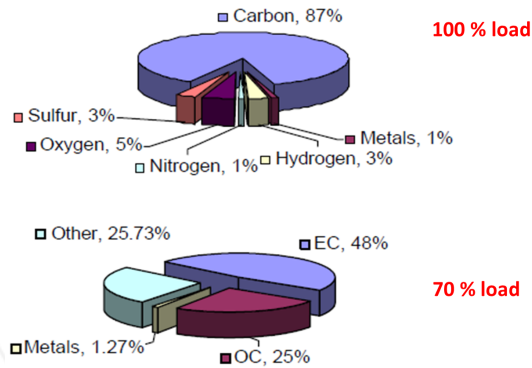

Figure 5. The influence of engine load in the particle composition [22].

In recent years, the emission of particles from vehicle exhaust is a phenomenon that has been much discussed because these are harmful to our health and the environment. Thus, in many countries, scientific research results were the basis for more restrictive legislation being implemented on emission of particulate matter from vehicle exhaust. This evolutionary process in search of a better quality of life for society by reducing the maximum allowable concentration of particulate emissions in vehicle exhaust, conditioned and demanded that the automotive industry and fuel producers seek innovative technologies to comply with the regulations. One of the ways that has been widely used to reduce emissions of some air pollutants, especially the emission of particulate matter are after-treatment devices such as urea-based selective catalytic reduction (SCR), diesel particulate filters (DPF), and diesel oxidation catalysts (DOC).

Nevertheless, the simultaneous reduction of particles and nitrogen oxides ( $\text{NO}_x$ ) is a big challenge, because the strategies for reducing one component may lead to an increase in another. For this reason, a variety of exhaust after-treatment devices is essential. For  $\text{NO}_x$  reduction, SCR is commonly used in on- and off-road engines [24,25]. However, DPF and DOC have also become more standard in off-road engines and are already common in motor vehicles [26]. DPF significantly lowers the particle mass emissions, but its effect on particle number is two-sided. The mass is dominated by the soot accumulation mode, which is efficiently trapped in DPF, but the particulate number can be dominated by nuclei mode particles formed downstream of the DPF [25], although the DPF seems to be capable of also removing ultrafine particles and nanoparticles effectively from the engine exhaust [27]. After-treatment of exhaust gas does not just lower emissions, but it also alters the chemical composition of vehicle exhaust [25].

Other technologies such as fuel injection pressure (FIP), the start of injection (SOI), and the application of exhaust gas recirculation (EGR) can also affect the particle emission profile. Li et al. (2014) [28] examined the effect of these technologies (FIP, SOI, and EGR) on particle number size distributions (PNDs) and OC and EC emissions from a common rail diesel engine. In general, it was observed that increasing FIP and advancing SOI can improve combustion, soot and accumulation mode particle (AM) emissions decrease with increasing FIP and



advancing SOI, the application of EGR increases soot and AM emissions, and soot-EC emission increases with the application of EGR at high load (Figure 6).

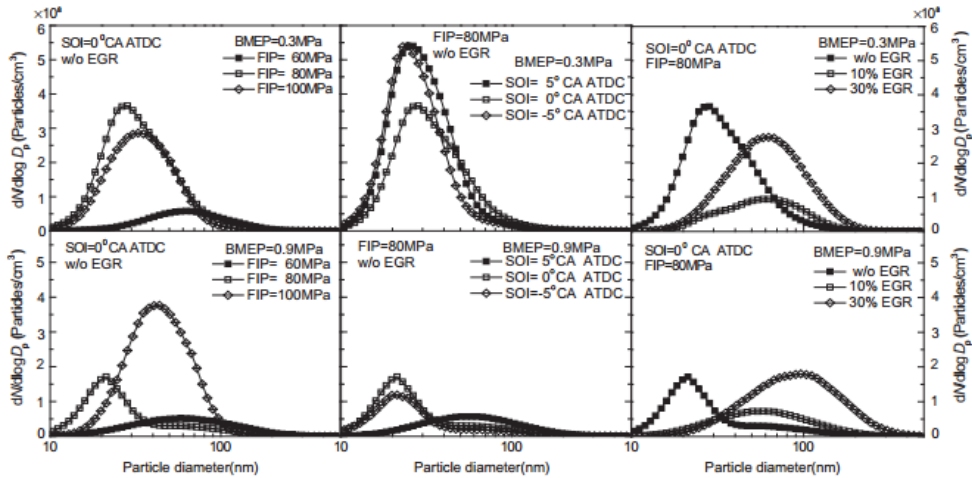
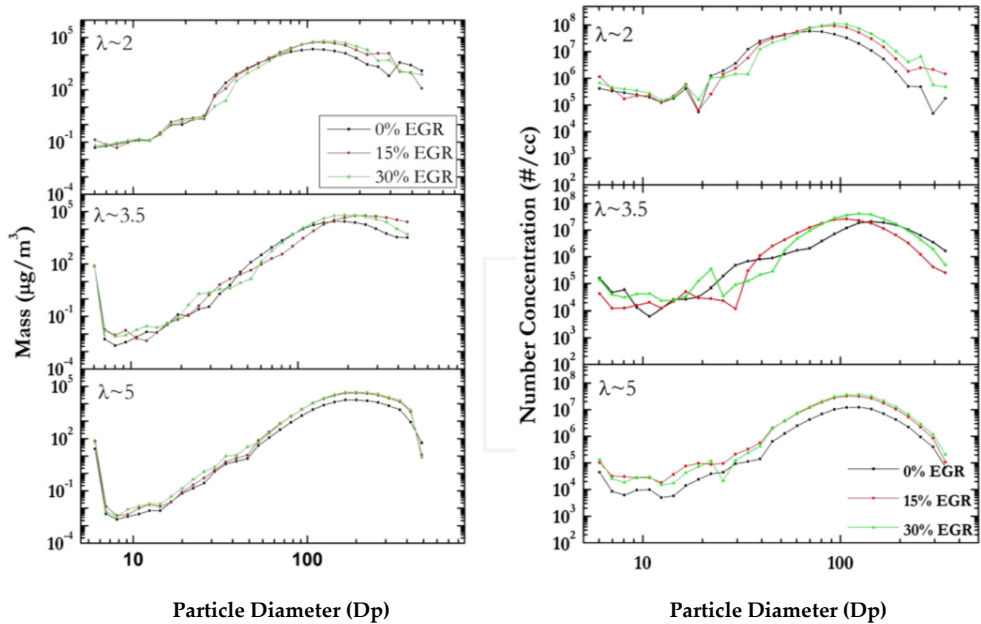

Figure 6. Effects of FIP, SOI, and EGR on particle number distributions [28].

In 2013, Agarwal et al. [29] developed an electrically heated diesel vaporizer to study the effect of use of different relative air fuel ratios and EGR levels on particle emission. They compared the emissions from conventional CI engines with an advanced combustion technology named as homogeneous charge compression ignition (HCCI). Figures 7a and 7b, show the results obtained for both mass and particle number concentrations. PM emissions were simultaneously reduced in HCCI combustion mode. However, particulate emissions from the HCCI engine largely depend on the EGR rate and relative air-fuel ratio. When the air-fuel mixture becomes leaner (increasing I), the PM mass emission decreases from diesel HCCI engine. With increasing EGR, the PM mass emission increases. The particle number concentration tends to increase also with an increase in EGR rate. Most of the diesel HCCI exhaust particles were ultrafine particles.

Ninga et al. (2004) [30] experimentally investigated the transformation of diesel particulates within the exhaust pipe when the exhaust gas is being cooled. The results showed that the transformation of the diesel particulates in the exhaust pipe depended mainly on the level of cooling, the concentration of the volatile materials, the initial concentration of the particulates in the exhaust, and the residence time of the exhaust gas within the exhaust pipe. The mass concentration and the soluble organic fraction of the particulates increased, while the gaseous hydrocarbon concentration decreased upon cooling the exhaust.

At high load conditions, although there is less volatile material in the exhaust, the original particulates in the exhaust can promote the condensation of the volatile materials and the coagulation between particulates upon cooling, so the particulate mass may also increase even



**Figure 7.** a) Particle mass and size distributions for various air-fuel ratios and EGR rates in diesel HCCI engine. (b) Number concentration of particles for various air-fuel ratios and EGR rate in diesel HCCI engine [29].

if the cooled temperature exceeds  $200^\circ\text{C}$ . Condensation of volatile materials and coagulation of particulates will be dominant in determining the number of small particulates when the engine load is higher than 30%, but when the cooled exhaust gas temperature is over  $200^\circ\text{C}$ , coagulation may be the primary mechanism leading to an increase in the number-average diameter of particulates [30].

### 3.2. Profile of particle emissions from Otto engines

Gasoline exhausts can be divided into three major components: gaseous phase, soot particles, and semi-volatile organics, which are distributed between the particulate and the gaseous phase. Correspondingly, its extracts include condensate (CD), particulate matter, and semi-volatile organic compounds (SVOC). Previous studies on gasoline exhausts focused primarily on the single component such as PM, CD, and SVOC. The studies on combination of these components are limited. In addition, efforts to reduce the total emission rate have led to modifications in fuel, engine, and after-treatment technology.

Currently, the automotive industry has been developing and applying the technology of direct injection engines in the Otto cycle to meet the challenges imposed by environmental legislation and to achieve energy efficiency. Despite the known advantages, such technology has negative factors, especially the formation of particulate.

The formation of PM in diesel engines is a phenomenon already known, however, in Otto engines, remains an issue to be further investigated, especially on the concentration of PM less than 2.5 microns ( $PM_{2.5}$ ) in nominal average diameter gas exhaust. The topic is important given the recent revision and imposition of the European legislation on emission limits for PM on direct injection engines.

In the automotive industry, with the evolution of the control of pollutant emission programs and strong demand for optimizing the motor's fuel consumption, new vehicle technologies continue to be introduced. Thus, seeking to combine the specific power of a gasoline engine with the efficiency of diesel engines, direct fuel injection has been developed and applied in Otto engines.

The development of four-stroke, spark-ignition engines that are designed to inject gasoline directly into the combustion chamber is an important worldwide initiative of the automotive industry. The thermodynamic potential of such engines for significantly enhanced fuel economy, transient response, and cold-start hydrocarbon emission levels has led to a large number of research and development projects that have the goal of understanding, developing, and optimizing gasoline direct-injection (GDI) combustion systems (Figure 8) [31].

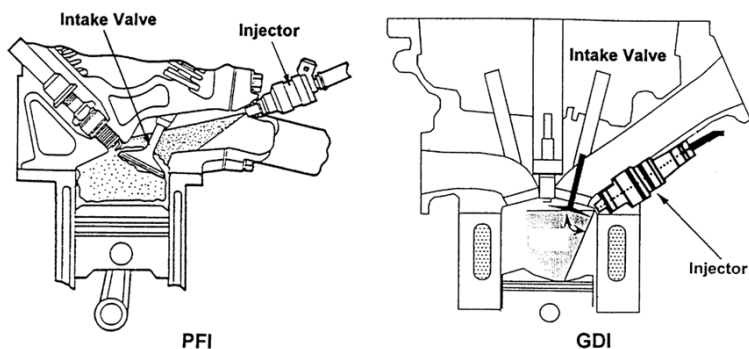
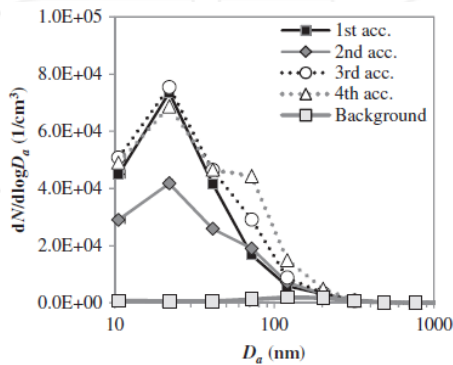

Figure 8. Different injection fuel systems: port-fuel-injected (PFI) and gasoline direct injection (GDI) [31].

The brake specific fuel consumption, and hence, the fuel economy, of compression-ignition, direct-injection (CID) diesel engine is superior to that of the port-fuel-injected (PFI) spark-ignition engine, mainly due to the use of a significantly higher compression ratio, coupled with unthrottled operation. The diesel engine, however, generally exhibits a higher noise level, a more limited speed range, and higher particulate and  $NO_x$  emissions than the spark ignition (SI) engine.

In a study of the particle emission characteristics using modern GDI passenger cars with the focus on exhaust particle number emissions and size distributions, the results indicate that both particle size below 30 nm and the other with mean particle size approximately 70 nm consisted of soot but with different morphologies (Figures 9 and 10) [32]. Significant emissions of exhaust particles were observed also during decelerations conducted by engine braking and

the particles most likely originated from lubricant oil ash components. The semi-volatile nucleation particles were observed at high engine load conditions. Thus, in general, the study indicates that a modern gasoline vehicle can emit four distinctive types of exhaust particles (Figure 10). Both during acceleration and steady conditions, the number size distribution of nonvolatile exhaust particles consisted of two modes, one with mean. In general, a major share of solid particles in the modern gasoline vehicle exhaust can be below this particle size limit, and during high engine load, vehicles can also emit small semi-volatile particles.



**Figure 9.** Particle number size distributions during the repetitions of acceleration tests from 30 km/h to 90 km/h [32].

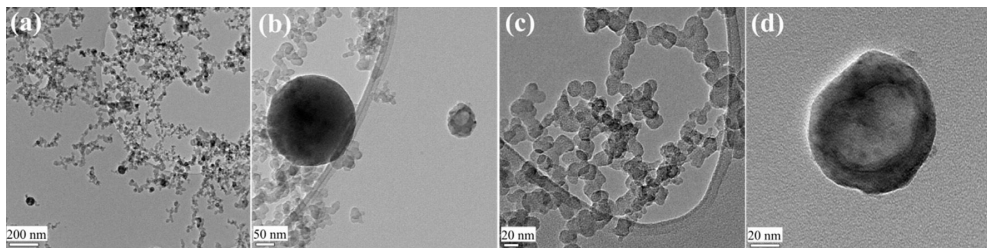
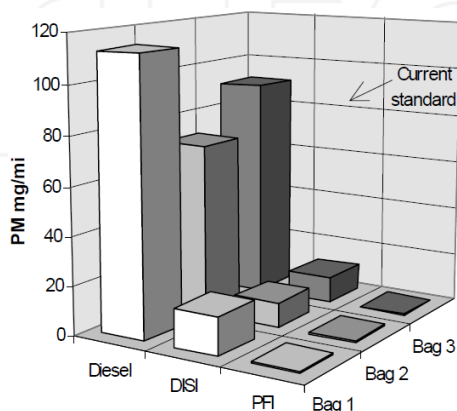

**Figure 10.** Transmission electron microscopy (TEM) images of collected exhaust particles during the New European Driving Cycle (NEDC) with various magnifications [32].

Two clearly distinct particle types were observed from samples collected over the whole NEDC. Firstly, around 10% to 20% of collected particles were nearly spherical (Fig. 10 a,b,d), often containing internal structure of lighter and darker areas. The size of those particles varied from 10 nm to even larger than 200 nm. These particles were composed of at least oxygen, zinc, phosphorous, and calcium where the metals are compounds of engine oil but not of fuel. The second particle type was agglomerated soot consisting of elemental carbon but also oxygen, zinc, phosphorous, and calcium. Note that also very small and nearly spherical soot-like particles were observed (Fig. 10b), possibly giving explanation for the bi-modal size distributions during acceleration and steady-state driving. However, the accumulated particles can

agglomerate also on the grid which prevents the direct comparison of the number of collected particles with particle size distributions [32].

In another study using a chassis dynamometer, Maricq et al. 1999 [33] compared the mass of particulate matter emitted by a vehicle direct injection with a premix vehicle and a diesel vehicle. As shown in Figure 11, the direct injection engine emitted approximately 10 times as much particulate material as the premix engine in driving US FTP-75 cycle. However, the emission of 10 mg/mi of particulate matter from direct injection engine was far from the North American boundary current at the time diesel, 80 mg/mi.



**Figure 11.** Comparison of the particulate matter emitted in the FTP-75 cycle [33], where DISI= direct-injection spark-ignited; and PFI= port fuel injected.

Another factor is that the exhaust gas fuel reforming has been identified as a thermochemical energy recovery technology with potential to improve gasoline engine efficiency, and thereby, reduce CO<sub>2</sub> in addition to other gaseous and PM emissions. The principle relies on achieving energy recovery from the hot exhaust stream by endothermic catalytic reforming of gasoline and a fraction of the engine exhaust gas. The hydrogen-rich reformat has higher enthalpy than the gasoline fed to the reformer and is recirculated to the intake manifold, that is, the reformed exhaust gas recirculation (REGR).

The REGR system was simulated by supplying hydrogen and carbon monoxide (CO) into a conventional EGR system. The hydrogen and CO concentrations in the REGR stream were selected to be achievable in practice at typical gasoline exhaust temperatures. Emphasis was placed on comparing REGR to the baseline gasoline engine, and also to conventional EGR. The results demonstrate the potential of REGR to simultaneously increase thermal efficiency, reduce gaseous emissions, and decrease PM formation [34].

In general, Kittelson & Kraft conclude that two mechanisms of precursor formation of particulate matter in the Otto engines' direct injection were identified. The first relates to the stratified operating condition, that is, when the fuel injection occurs in the compression phase. Due to the short time between injection and the spark, the fuel vaporization is not complete,

so the air/fuel mixture presents heterogeneous characteristics, that is, fuel-rich regions with great potential for the formation of particulate matter. The second is mainly related to the homogeneous condition, that is, even when the fuel is injected in the admission phase, thus creating an accumulation of fuel on the cylinder walls, a potential source for the formation of particulate material [4].

In this context, the particle emissions of vehicles are restricted by emission standards which have significant variations depending on the country. In the US, since 2004, the same standards have been applied to vehicles regardless of the fuel and thus, the limits for the particulate mass emission have also covered the Otto vehicles. In the European Union, a particulate mass emission limit for direct injection Otto engines took effect in 2009 (Euro 5), and the first restrictions for particle number emissions will come into effect in 2014 (Euro 6). Thus, globally, the particle emission limitations for gasoline vehicles are under strong development [32,35].

#### **4. Impact of the biofuel burning on particle emissions from the vehicular exhaust**

Biofuels are obtained from biomass, the name given to the organic material in an ecosystem or a vegetable or animal population. As plants and animals may be continuously reproduced, it can be considered renewable energy sources. There are several types of biofuels that can be produced from biomass, such as alcohol (methanol and ethanol), biodiesel, bio-kerosene and others, and sources for this production can be both of animal origin (for example tallow or chicken fat) and vegetable (e.g. vegetable oils and cane sugar) [36].

In chemical terms, biodiesel is a mixture of alkyl esters from fatty acids and can be produced from plant-derived oils, waste oils and fats (resulting from domestic, commercial, and industrial processes such as, for example, frying) or animal fats. Dozens of plant species can be used for the production of this biofuel, such as soybean, palm, sunflower, babassu oil, peanut, castor, jatropha, and others [36].

We can highlight biodiesel and ethanol as among these fuels that can be used in internal combustion engines without requiring major modifications. The use of these biofuels can bring great changes in the emission of particulate matter profile, which will be discussed below. PM emissions have become a major concern due to their environmental impact [3]. In recent years, the law which governs the issuance of pollutants has forced manufacturers and automakers to develop engines and cleaner cars. In this scenario, fuels from renewable sources received considerable prominence and emerged as alternatives to fossil fuels. Several tests have been conducted with biodiesel and ethanol to ascertain the impacts on engine performance, fuel consumption, and exhaust emission, mainly in relation to diesel [3,37].

The differences on performance, combustion, and emission of biodiesel are caused by the difference existing between this and the diesel from fossil oil and chemical thermophysical properties such as density, cetane number, and oxygen content, being higher in biodiesel than in diesel [3].

Ethanol already has low cetane number which may lead to insufficient self-ignition quality for direct use of these alcohols in unmodified diesel engines. The key property of ethanol is its high octane number. The addition of ethanol to gasoline raises the octane value of gasoline and reduces engine knock, without affecting the efficiency of the catalytic converter [38]. Indeed, when Henry Ford designed his first automobile (Model T), it was built to run on both gasoline and pure ethanol [39].

Experimental studies have claimed that ethanol-blended fuels reduce exhaust emissions compared with gasoline-fueled engine. Generally, in these studies, the reductions in the exhaust emissions have been associated with the oxygen content of ethanol. It is well-known that the physical and chemical properties of ethanol are completely different from those of gasoline. In particular, their energy contents are lower than that of gasoline, both on mass and volume basis. This property shows that the engine will need more amount of fuel when it is fueled with ethanol blends to produce the same power output in a gasoline-fueled engine. This case will change air/fuel ratio in the cylinder and exhaust emission levels. One of the most important properties of both ethanol and biodiesel, compared with gasoline and diesel, is the oxygenated atoms in their molecular compounds which provide significant reduction in the CO and HC emissions, but it may adversely affect NO<sub>x</sub> emissions [3,40,41].

Unlike biodiesel, which is applied only in diesel cycle engines, ethanol can be used in both diesel and Otto cycle engines. Due to the advantages of biodegradability, low toxicity as well as high miscibility with diesel fuel relative to ethanol, as an oxygenous biomass fuel, ethanol has also received considerable attention. In particular, its regenerative capability and cleaner burning characteristics make ethanol so attractive that it may also be considered as a predominant alternative fuel for diesel engines. Researches indicated that the ethanol–diesel blended fuels were technically acceptable for existing diesel engines. At present, there is a widespread interest in ethanol–diesel blended fuels for their potential to help reduce harmful exhaust emissions from current and future diesel engines. The first studies on the use of ethanol in diesel engines were conducted in South Africa in the 1970s, and continued in Germany and the United States during the 1980s through the work of Caro et al., 2001 [42].

Numerous experimental results indicate that ethanol/diesel blends could significantly reduce PM and smoke emissions. Table 1 shows some research results about PM emissions using biodiesel/diesel blends.

In a very comprehensive study on the impact of using biofuel (biodiesel) in the emission of particulate matter, the size, concentration, and number of particles are observed to have been directly influenced by the concentration of biodiesel added to diesel fuel, the engine load conditions, and also after-treatment technology adopted. Younga et al. [47] observed that the size distributions at 0% load were very different from other test modes and were bimodal, showing a predominant core mode of 15 nm and a substantially minor soot mode of ~ 68 nm. At above 25% load, the core mode disappeared. Instead, the size distributions were unimodal with a soot mode that increased in concentration and size with increasing load from 25%, 50% to 75% (Figure 12a) [47].

Ref.	Fuel	Embedded Technology	Emissions PM
[43]	10% and 15% ethanol to diesel	-	Reduce by 20%–27%
[44]	E0 (base diesel fuel), E5 (5%), E10 (10%), E15 (15%) and E20 (20%), base diesel fuel	-	Reduce by 30%–40%; the more ethanol was added, the less smoke emitted
[45]	blends containing 83%–94% diesel fuel, 5%–15% ethanol and 1%–3% additive cetane improver	-	15% ethanol–diesel blends could produce a drop of 33.3% in smoke and 32.5% in the soot mass concentration
[46]	blends containing ethanol fumigation is 20% improver	-	reduction of 51% in soot mass concentration
[47]	waste cooking oil biodiesel blends (B2, B10 and B20), engine loads (0%, 25%, 50% and 75%)	diesel oxidation catalyst plus diesel particulate filter (DOC +DPF)	Particle number concentration at a given load, reduce with increasing of biodiesel blend; DOC + DPF removed >99.84% nonvolatile particle

Table 1. Research results about PM emissions using biofuel/fossil fuel blends.

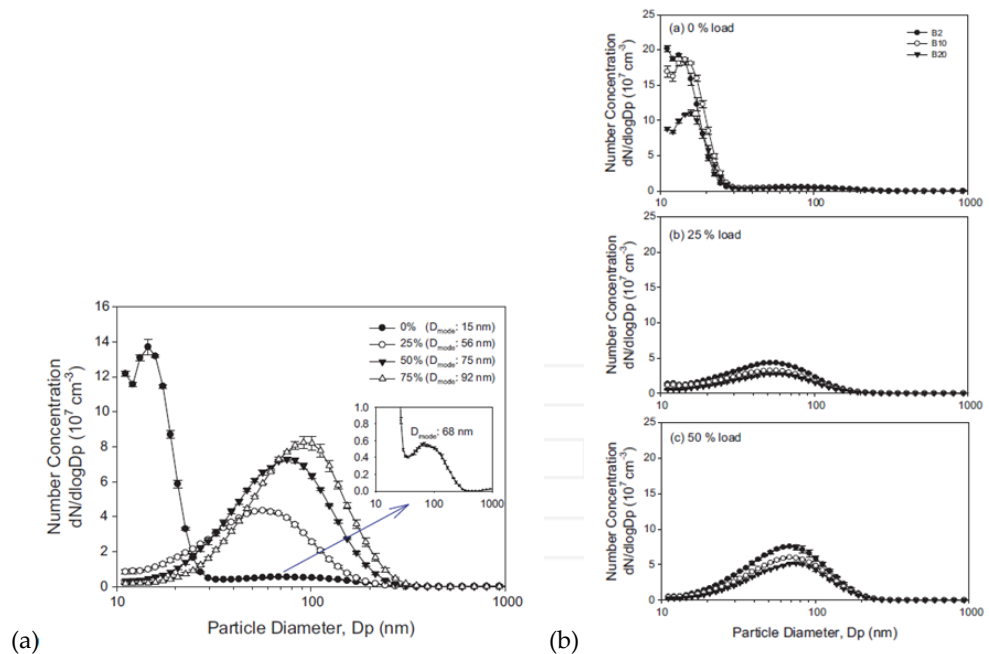
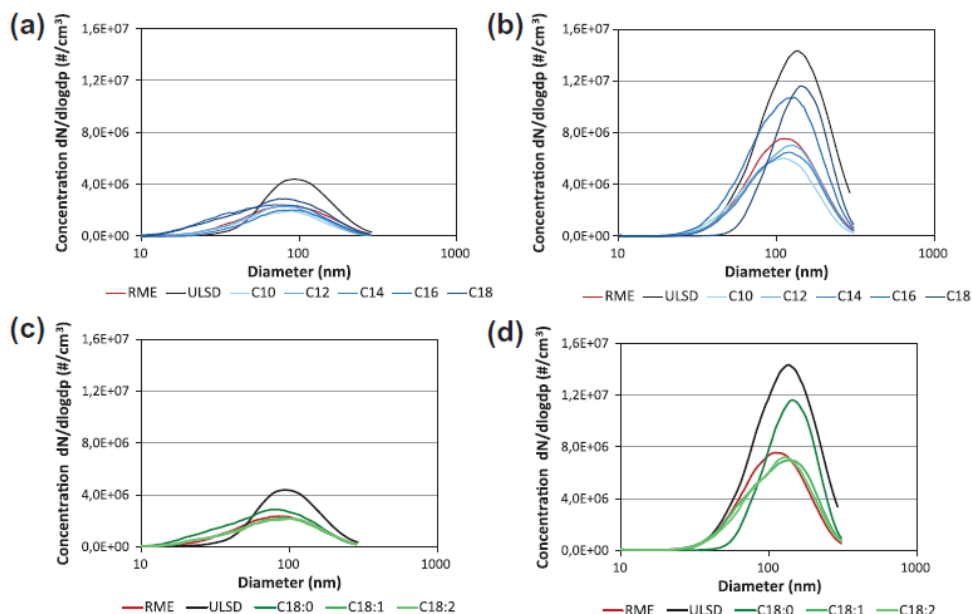

Figure 12. a) Average nonvolatile particle size distributions in pre-DOC + DPF exhaust at different engine loads using B2; (b) average nonvolatile particle size distributions in pre-DOC + DPF exhaust at (a) 0%, (b) 25%, and (c) 50% load using B2, B10 and B20 [47].



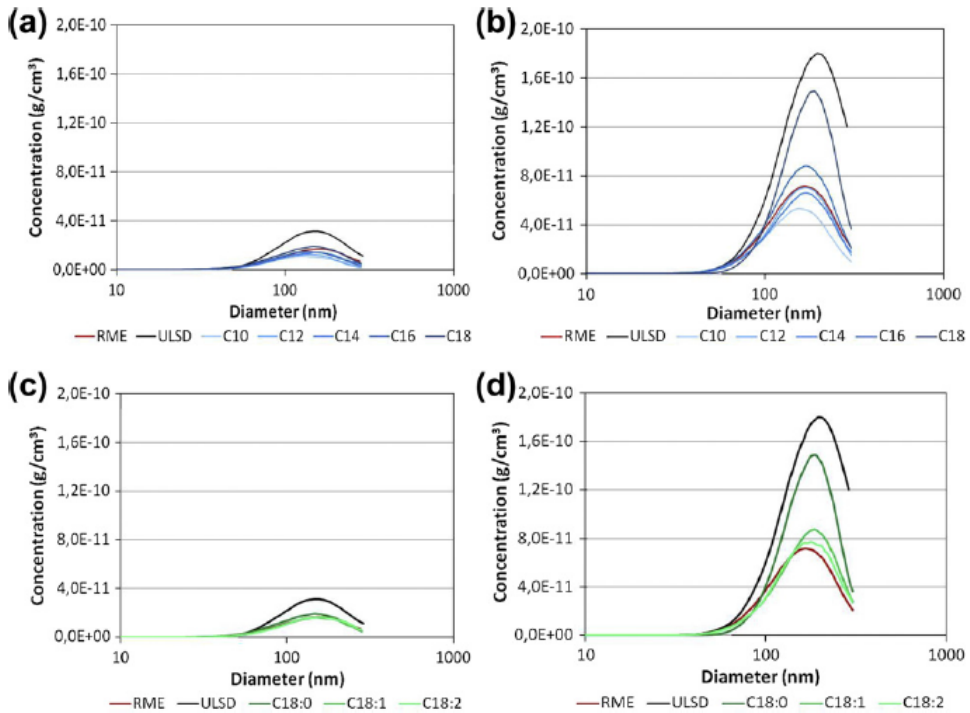

**Figure 13.** Particle number distribution: (a) effect of chain length, 0% EGR; (b) effect of chain length, 30% EGR; (c) effect of unsaturation, 0% EGR, and (d) effect of unsaturation, 30% EGR [48].

Figure 12b shows the effect of biodiesel concentration added to diesel in the particle size number concentration (Younga et al. research). At 0% load, the number of core particles decreased with increasing biodiesel blend. At 25% and 50% load, the number of soot particles decreased with increasing biodiesel blend. Therefore, the number reduction with increasing biodiesel blend was not limited to soot particles but also included the core particles. This is likely due to the increased oxygen content, lower aromatic content, prolonged soot oxidation time, and lower final boiling point with increasing biodiesel blend [47].

Besides the concentration of biodiesel present in the diesel fuel, it can be said that the properties and source of biodiesel used distribution can impact the size and number of particles emitted in the exhaust profile. This impact was observed by Pinzi and colleagues [48] in a study which showed varied effects of fatty acid methyl esters on the molecular structure (saturation degree and chain length) present in rapeseed oil methyl esters (RME - biodiesel). Furthermore, the effect of the use of EGR in the particle emission profile was also evaluated (Figures 13 and 14) [48]. The results were compared with those obtained for ultra low sulphur diesel (ULSD) burning.

Through Figures 13 and 14, one can observe that the results obtained by Pinzi et al. [4] showed that the ULSD fuel particle size distributions are greater and are predominantly at larger diameters than in the case of the fat acid methyl esters (FAME). All the methyl esters (including



**Figure 14.** Mass particle size distribution: (a) effect of chain length, 0% EGR; (b) effect of chain length, 30% EGR; (c) effect of unsaturation, 0% EGR, and (d) effect of unsaturation, 30% EGR [48].

RME) gave lower total number (Figure 13) and mass emissions (Figure 14) of the particles than ULSD fuel. Moreover, during EGR conditions the total mass of particles of methyl esters was around 60% of the ULSD PM emission.

Guarieiro et al. [49] investigated the influence of the use of ethanol as an additive to biodiesel/diesel blend in the size and number distribution of particles and the results obtained are shown in Figure 14. The fuels evaluated were B5 (diesel with 5% of biodiesel); B5E6 (ternary composition containing 89% diesel, 5% of biodiesel and 6% of ethanol); and B100 (100% of biodiesel). The burning of fuels showed concentrations of particles trendy accumulation of  $50 > Da > 200$  nm (Figure 15). In general, particles emitted from diesel engines are in the size range 20–130 nm. The geometric mean obtained for both fuels B5 and B5E6 was  $\delta=86.6\pm 3.7$  nm, with a total number of particles of  $9.6 \times 10^6$  particles/cm<sup>3</sup> for the B5 and  $1.1 \times 10^7$  particles/cm<sup>3</sup> to the B5E6. The B100 showed geometric mean of  $\delta=78.1\pm 3.1$  nm with total number of particles of  $1.4 \times 10^7$  particles/cm<sup>3</sup>. It was observed by the authors that there was an increase in the number of smaller particulate emissions when biodiesel is used instead of blended diesel with alcohol fuel.

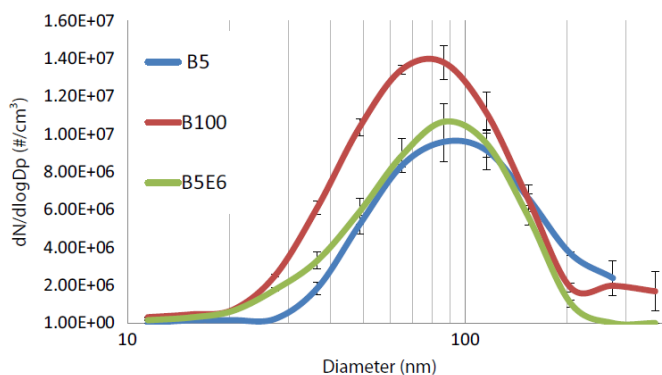

Figure 15. Distribution of number and size particles for fuels: B5, B5E6, and B100 [49].

The engine used in Guarieiro's research [49] has a mechanical injection, an anticipated injection can happen due to high modulus of volumetric compressibility of the B100, and this makes it longer to mix with air. Thus, there is an increase in premixed combustion fraction due to the ignition delay that can generate a lesser incomplete burning, reducing the size of the particles and consequently, increasing their concentration. However, the nucleation, condensation, and coagulation of the HC in the engine exhaust will generate some particles, leading to more particulates, both in number and in mass, than the B5 and B5E6.

Besides the physical characterization of particles emitted from burning diesel/biodiesel fuel blends, there are some studies in the literature that also evaluate the impact of biodiesel use in the chemical composition of the particles. The effects of diesel/biodiesel blends on the physical, chemical, and toxicological properties of diesel engine exhaust at low condition were investigated through the study of the changes in size-distribution and emission factors of PAH associated to PM [50]. For that, particle emissions from commercial petroleum-based diesel with 4% of soy biodiesel (B4), a biodiesel blend of 25% and 50% (B25 and B50), and also pure biodiesel (B100) were measured using a diesel engine at low load. PM was distributed in all sizes, while PAH size distribution was found in higher levels in the accumulation mode ( $30 \text{ nm} < D_p < 2.5 \text{ }\mu\text{m}$ ). Total PAH emission factors ( $\text{ng kg}^{-1} \text{ fuel}$ ) for B4, B25, B50, and B100 were 237,111,182, and 319  $\text{ng kg}^{-1} \text{ fuel}$ , respectively. Individual PAH emission factors showed that PAH containing four or more rings ( $MW > 202$ ) such as BBF, BAA, PYR, and BGP were the main PAH emitted by the four studied fuels. The percentage reductions of individual PAH emission factors for the blended fuels in comparison with B4 were 37% and 22% for B25 and B50, respectively, and an increase of around 31% for B100. On the other hand, an increase in redox activity was observed for B25, B50, and B100 when compared with B4. In general, the results from our study suggest that emissions from pure waste cooking biodiesel may not be the better fuel choice in terms of PM, PAH, and BaPE particle size distribution and emission factors as well as redox activity (Figure 16). However, B25 and B50 blends presented some improvements in terms of PM, HPA, and BaPE size distribution and redox activity of engine exhaust in comparison with B4. This suggests that the addition of low percentages of biodiesel to diesel promotes benefits in both environmental and human health concerns [50].

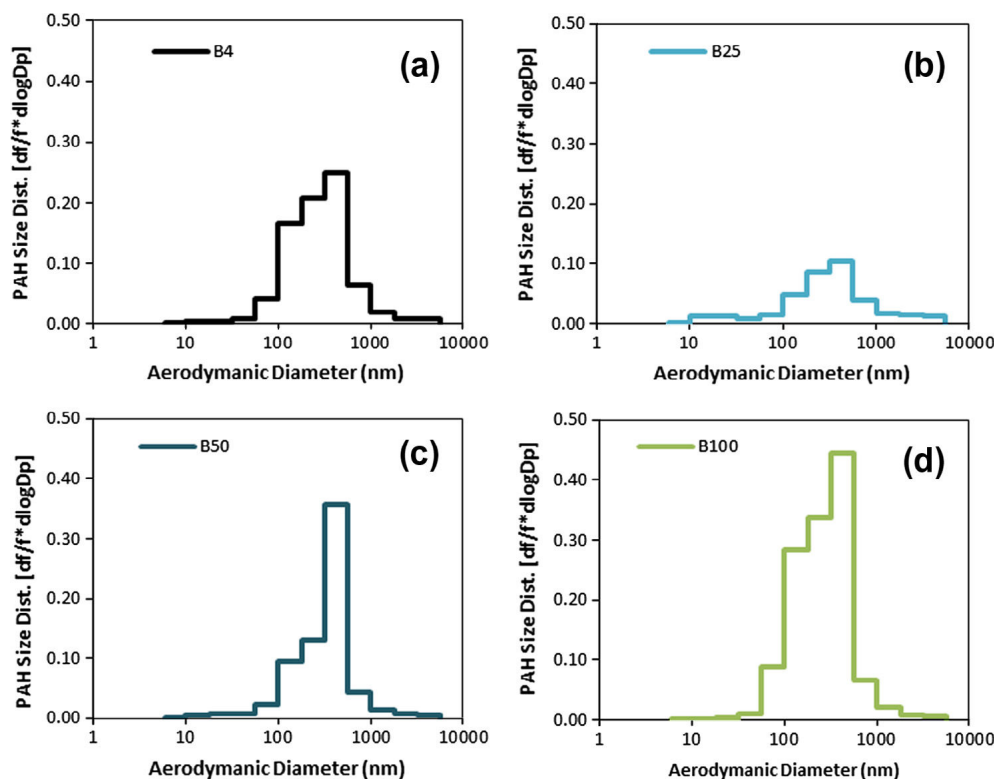

Figure 16. PAH size-distributed emission factors for the studied diesel/biodiesel fuels [50].

The study of PAH size distribution (Figure 16) shows a unimodal size distribution for all fuels peaking at 320–560 nm. Approximately 90%–99% of PAH were present in particles smaller than 1.8  $\mu\text{m}$  for all fuels, and about 80% of them are found in particles between 56 nm and 1.8  $\mu\text{m}$ . This broad size-distribution of PAHs starting in the range of nanoparticles and ending in small particle sizes is important for assessing the possible health effects associated with exposure to biodiesel emissions, as particle size will determine deposition and its chemical composition for possible adverse outcomes [50].

There are few studies on the impact of the use of ethanol/gasoline in emissions of particulate matter. However, some research points to the fact that the addition of ethanol in gasoline cannot have an effect on the number of emitted particles and their diameter by difference in the four-stroke moped engine [51] and particle number and diameter are reduced by 60% and 90%, respectively, when blends of ethanol/gasoline are applied over pure gasoline fuels, at all engine cycles [52].

Thus, the differences in particle characteristics and formation should be taken into account in the development of emission control strategies and of technologies for the assessment of the impact of particle emissions on the environment and human health. Nowadays, for PM, the

regulated value is the total mass. Nevertheless, particle number and particle size distribution give more information than mass alone, because it is known that small particles have longer residence time in the atmosphere, and are more reactive and are more difficult to trap. Moreover, these small particles can reach the pulmonary alveoli, while larger particles deposited in the upper airways are easier to eliminate. Thus, small particles, especially ultrafine particles under 100 nm, are considered critical to human health and research about their impact with the use of biofuels should be developed more and more to understand what the real impact of biofuel in particle emissions is.

## Acknowledgements

The authors wish to thank the SENAI CIMATEC and Brazilian agencies: CNPq, FAPESB, CAPES, FINEP, PRH55 ANP/MCTI and INCT for Energy & Environment.

## Author details

Lílian Lefol Nani Guarieiro<sup>1,2</sup> and Aline Lefol Nani Guarieiro<sup>3</sup>

1 SENAI-CIMATEC, Salvador, BA, Brazil

2 INCT de Energia e Ambiente, UFBA, Salvador, BA, Brazil

3 Cetrel Odebrecht Ambiental, Rio de Janeiro, RJ, Brazil

## References

- [1] Lima MMC. Estimativa de concentração de material particulado em suspensão na atmosfera por meio da modelagem de redes neurais artificiais. Tese de mestrado defendida na Escola de Engenharia 2006, UFMG.
- [2] EPA 2014 – Particle Matter disponible <http://www.epa.gov/pm/> (accessed in July 15, 2015),
- [3] Guarieiro LLN, Guarieiro ALN. Vehicle Emissions: What Will Change with Use of Biofuel? INTECH, Biofuels - Economy, Environment and Sustainability 2012; Chapter 14: 357-386.
- [4] Kittelson D, Kraft M. Particle Formation and Models in Internal Combustion Engines. United Kingdom: University of Cambridge, 2014.

- [5] Kittelson DB. Recent Measurements of nanoparticles emissions from engines. Current research on diesel exhaust particles japan association of aerosol science and technology 2001.
- [6] Jung H, Kittelson DB. Measurement of electrical charge on diesel particles. *Aerosol Sci Technol* 2005; 39: 1129-1135.
- [7] EPA 2005; Chapter 4 - Air Quality: Characterization and Implications', United States Environmental Protection Agency, Office of Air Quality Planning and Standards, Research Triangle Park, NC 27711, USA.
- [8] Morrow PE, Bates DV, Fisher BR, et al., Deposition and Retention Models for Internal Dosimetry of the Human Respiratory Tract (Report of the international Commission on Radiological Protection: ICRP: Task Group on Lung Dynamics). *Health Phys.* 1964; 12:173-207.
- [9] Raabe OG. Deposition and Clearance of Inhaled Aerosols. Mechanism in Respiratory Toxicology 1982; 1: 27-76. H. Witschi and P. Nettesheim, Eds. Boca Raton, FL: CRC Press, 1982.
- [10] Kelly FJ, Fussell JC. Size, source and chemical composition as determinants of toxicity attributable to ambient particulate matter. *Atmos Environ* 2012; 60: 504-526.
- [11] Zhang Q, Stanier CO, Canagaratna MR, Jayne JT, Worsnop DR, Pandis SN, Jimenez JL. Insights into the chemistry of new particle formation and growth events in Pittsburgh based on aerosol mass spectrometry, *Environ. Sci. Technol.* 2004; 38: 4797-4809.
- [12] Lim YB, Ziemann PJ. Products and mechanism of secondary organic aerosol formation from reactions of n-alkanes with OH radicals in the presence of NO<sub>x</sub>. *Environ. Sci. Technol.* 2005; 39: 9229-9236.
- [13] Li N, Xia T, Nel AE. The role of oxidative stress in ambient particulate matter-induced lung diseases and its implications in the toxicity of engineered nanoparticles. *Free Radical Biol Med* 2008; 44: 1689-1699.
- [14] Claxton LD, Matthews PP, Warren SH. The genotoxicity of ambient outdoor air, a review: Salmonella mutagenicity, *Mutat. Res.* 2004; 567: 347-399.
- [15] Jakober CA, Riddle SG, Robert MA, Destailats H, Charles MJ, Green PG, Kleeman MJ. Quinone emissions from gasoline and diesel motor vehicles. *Environ. Sci. Technol.* 2007; 41: 4548-4554. T otlandsdal AL, Herseth JL, Bolling AK, Kubátová A, Braun A, Cochran RE, Refsnes M, Ovrevik J, Låg M. Differential effects of the particle core and organic extract of diesel exhaust particles. *Toxicol Lett.* 2012; 208: 262-268.
- [16] Kong S, LU B, JI Y, ZHAO X, CHEN LI, LI Z, HAN B, BAI Z. Levels, risk assessment and sources of PM10 fraction heavy metals in four types dust from a coal-based city. *Microchem J* 2011; 98: 280-290.

- [17] IPCS. 1996. Environmental Health Criteria No. 171. Diesel Fuel and Exhaust Emissions. International
- [18] Programme on Chemical Safety. <http://www.inchem.org/documents/ehc/ehc/ehc171.htm>.
- [19] CAL EPA (California Environmental Protection Agency), 1998. Part B: Health Risk Assessment for Diesel Exhaust, Proposed Identification of Diesel Exhaust as a Toxic Air Contaminant. Office of Environmental Health Hazard Assessment (OHEEA).
- [20] Schuetzle D, Perez JM. Factors influencing the emissions of nitrated-polynuclear aromatic hydrocarbons (nitro-PAH) from diesel engines. *J Air Pollut Control Assoc.* 1983; 33(8): 751-755.
- [21] Schuetzle D, Jensen TE, Ball JC. Polar polynuclear aromatic hydrocarbon derivatives in extracts of particulates: Biological characterization and techniques for chemical analysis. *Environ Int.* 1985; 11(2-4): 169-181.
- [22] Sharma M, Agarwal AK, Bharathi KVL. Characterization of exhaust particulates from diesel engine. *Atmospheric Environment* 2005; 39: 3023–3028.
- [23] Pierson WR, Brachaczek WW. Particulate matter associated with vehicles on the road--II. *Aerosol Sci. Technol.* 1983; 2: 1-40.
- [24] López JM, Jiménez F, Aparicio F, Flores N. On-road emissions from urban buses with SCR þurea and EGRþ DPF systems using diesel and biodiesel. *Transport Res* 2009; Part D, 14: 1–5.
- [25] Maricq M.M. Chemical characterization of particulate emissions from diesel engines: a review. *J Aerosol Sci* 2007; 38: 1079–1118.
- [26] Mooney JJ. Toxic solid nanoparticles, the importance of retrofitting diesel engine particle emission control systems to older in-use diesel engines, and available methods. *Österreichische Ingenieur- und Architekten Zeitschrift (ÖIAZ)* 2007; 152: 1–3.
- [27] Niemi S, Lundin K, Karhu T, Laurén M, Ekman K, Nousiainen P, Paanu T. Exhaust particle number in off-road engines of different generations. *SAE Paper* 2009; 01-1869: 1–11.
- [28] Li X, Xu Z, Guan C, Huang Z. Particle size distributions and OC, EC emissions from a diesel engine with the application of in-cylinder emission control strategies. *Fuel* 2014; 121: 20–26.
- [29] Agarwal AK, Singh AP, Lukosea J, Guptab T. Characterization of exhaust particulates from diesel fueled homogenous charge compression ignition combustion engine. *J Aerosol Sci* 2013; 58: 71–85.
- [30] Ninga Z, Cheung CS, Liu SX. Experimental investigation of the effect of exhaust gas cooling on diesel particulate. *Aerosol Sci* 2004; 35: 333–345.

- [31] Zhao F, Lai MC, Harrington DL. Automotive spark-ignited direct-injection gasoline engines. *Progr Energy Combust Sci* 1999; 25: 437-562.
- [32] Karjalainen P, Pirjola L, Heikkila, Lahde T, Tzamkiozis T, Ntziachristos L, Keskinen J, Ronkk I. Exhaust particles of modern gasoline vehicles: A laboratory and an on-road study. *Atmos Environ* 2014; 97: 262-270.
- [33] Maricq MM, Podsiadlik DH, Brehob DD, Haghgoie M. Particulate Emissions from a Direct-Injection Spark-Ignition (DISI) Engine. SAE Technical Paper 1999; 1999-01-1530.
- [34] Fennell D, Herreros J, Tsolakis A. Improving gasoline direct injection (GDI) engine efficiency and emissions with hydrogen from exhaust gas fuel reforming. *Int J Hydrogen Energy* 2014; 39: 5153-5162.
- [35] Dieselnet, [www.dieselnet.com](http://www.dieselnet.com), information retrieved: 14.1.2014.
- [36] Guarieiro LLN, Torres EA, De Andrade JB. Energia verde. *Ciência Hoje* 2011; 48 (285): 36-41.
- [37] Imtenan S, Masjuki HH, Varman M, Kalam MA, Arbab MI, Sajjad H, Ashrafur Rahman SM. Impact of oxygenated additives to palm and jatropha biodiesel blends in the context of performance and emissions characteristics of a light-duty diesel engine. *Energy Convers Manage* 2014; 83: 149-158.
- [38] Agarwal AK. Biofuels (alcohols and biodiesel) applications as fuels for internal combustion engines. *Prog Energ Combust* 2007; 33: 233-271.
- [39] Sward K. *The legend of Henry Ford*. 1st ed. New York: Rinehart; 1948.
- [40] Canakci M, Ozsezen AN, Alptekin E, Eyidogan M. Impact of alcohol-gasoline fuel blends on the exhaust emission of an SI engine. *Renew Energy* 2013; 52: 111-117.
- [41] Guarieiro LLN, Vasconcellos PC, Solci MC. Poluentes Atmosféricos Provenientes da Queima de Combustíveis Fósseis e Biocombustíveis: Uma Breve Revisão. *Revista Virtual de Química* 2011; 3 (5): 434-445.
- [42] Caro PS, Mouloungui Z, Vaitilingom G. Interest of combining an additive with diesel-ethanol blends for use in diesel engines. *Fuel* 2001; 80: 565-574.
- [43] Spreen K. Evaluation of oxygenated diesel fuels. Final Report for Pure Energy Corporation Prepared at Southwest Research Institute, San Antonio, TX, 1999.
- [44] Kass MD, Thomas JF, Storey JM, Domingo N, Wade J, Kenreck G. Emissions from a 5.9 L diesel engine fueled with ethanol-diesel blends. SAE Technical Paper Series No. 2001-01-2018.
- [45] Ahmed. Oxygenated diesel: emissions and performance characteristics of ethanol-diesel blends in CI engines. SAE Technical Paper Series No. 2001-01-2475.



- [46] Abu-Qudais M, Haddad O, Qudaisat M. The effect of alcohol fumigation on diesel engine performance and emissions, *Energy Convers Manage* 2000; 41: 389–399.
- [47] Younga L, Liou Y, Cheng M, Lu J, Yang H, Tsai YI, Wang L, Chen C, La J. Effects of biodiesel, engine load and diesel particulate filter on nonvolatile particle number size distributions in heavy-duty diesel engine exhaust. *J Hazard Mater* 2012; 199–200.
- [48] Pinzi S, Rounce P, Herreros JM, Tsolakis A, Dorado MP. The effect of biodiesel fatty acid composition on combustion and diesel engine exhaust emissions. *Fuel* 2013; 104: 170–182.
- [49] Guarieiro LLN, Guerreiro ETA, Amparo KKS, Manera VB, Regis ACD, Santos AG, Ferreira VP, Leão DJ, Torres EA, de Andrade JB. Assessment of the use of oxygenated fuels on emissions and performance of a diesel engine. *Microchem J* 2014; 117: 94–99.
- [50] Guarieiro ALN, Santos JVS, Eiguren-Fernandez A, Torres EA, da Rocha GO, de Andrade JB. Redox activity and PAH content in size-classified nanoparticles emitted by a diesel engine fuelled with biodiesel and diesel blends. *Fuel* 2014; 116: 490–497.
- [51] Seggiani M, Prati MV, Costagliola MA, Puccini M, Vitolo S. Bioethanol– gasoline fuel blends: exhaust emissions and morphological characterization of particulate from a mopet engine. *J Air Waste Manage Assoc* 2012; 62: 888–97.
- [52] Costagliola MA, De Simio L, Iannaccone S, Prati MV. Combustion efficiency and engine out emissions of a S.I. engine fueled with alcohol/gasoline blends. *Appl Energy* 2013 ;111: 1162–71.

INTECH

